

JRTK187..

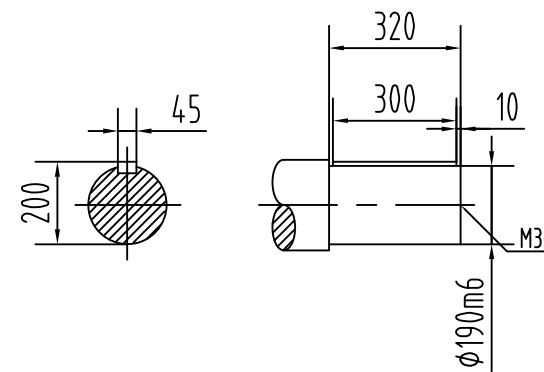

JRTKH187B..

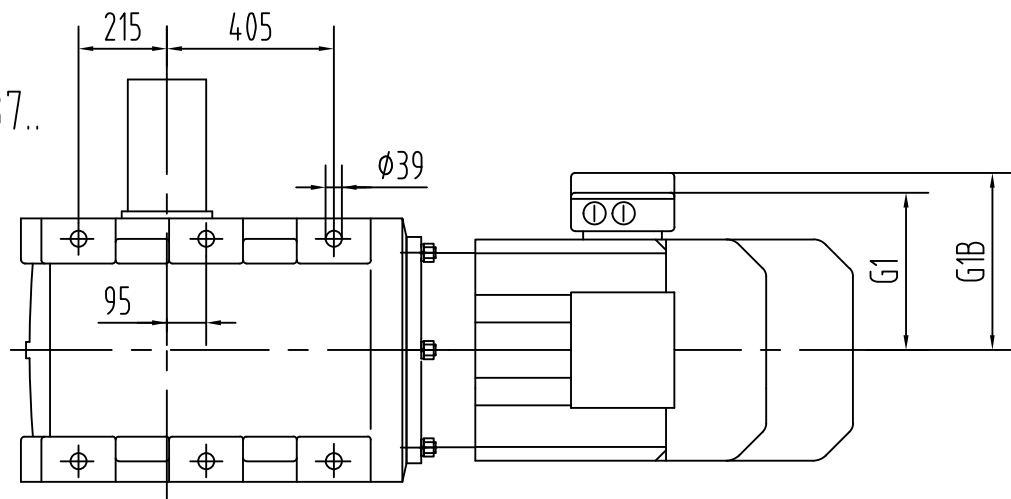
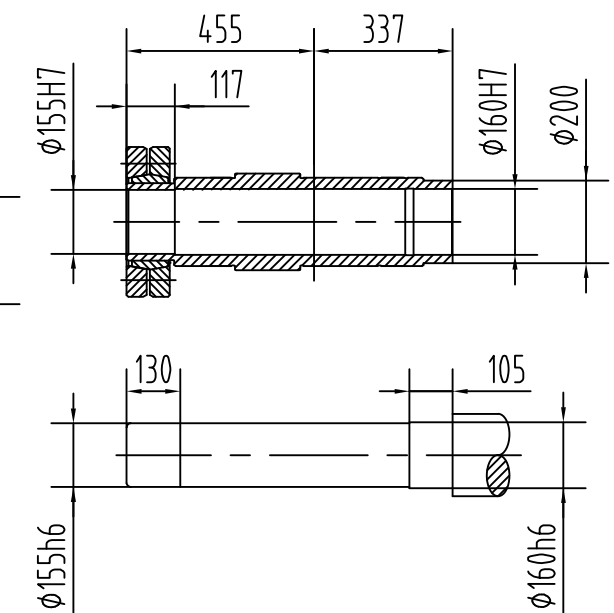
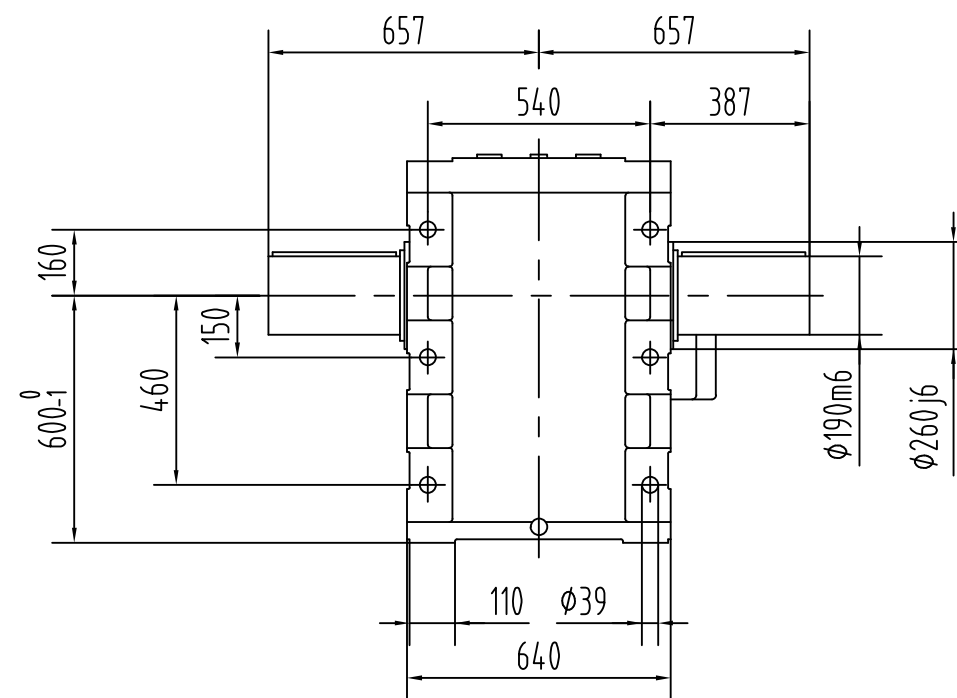
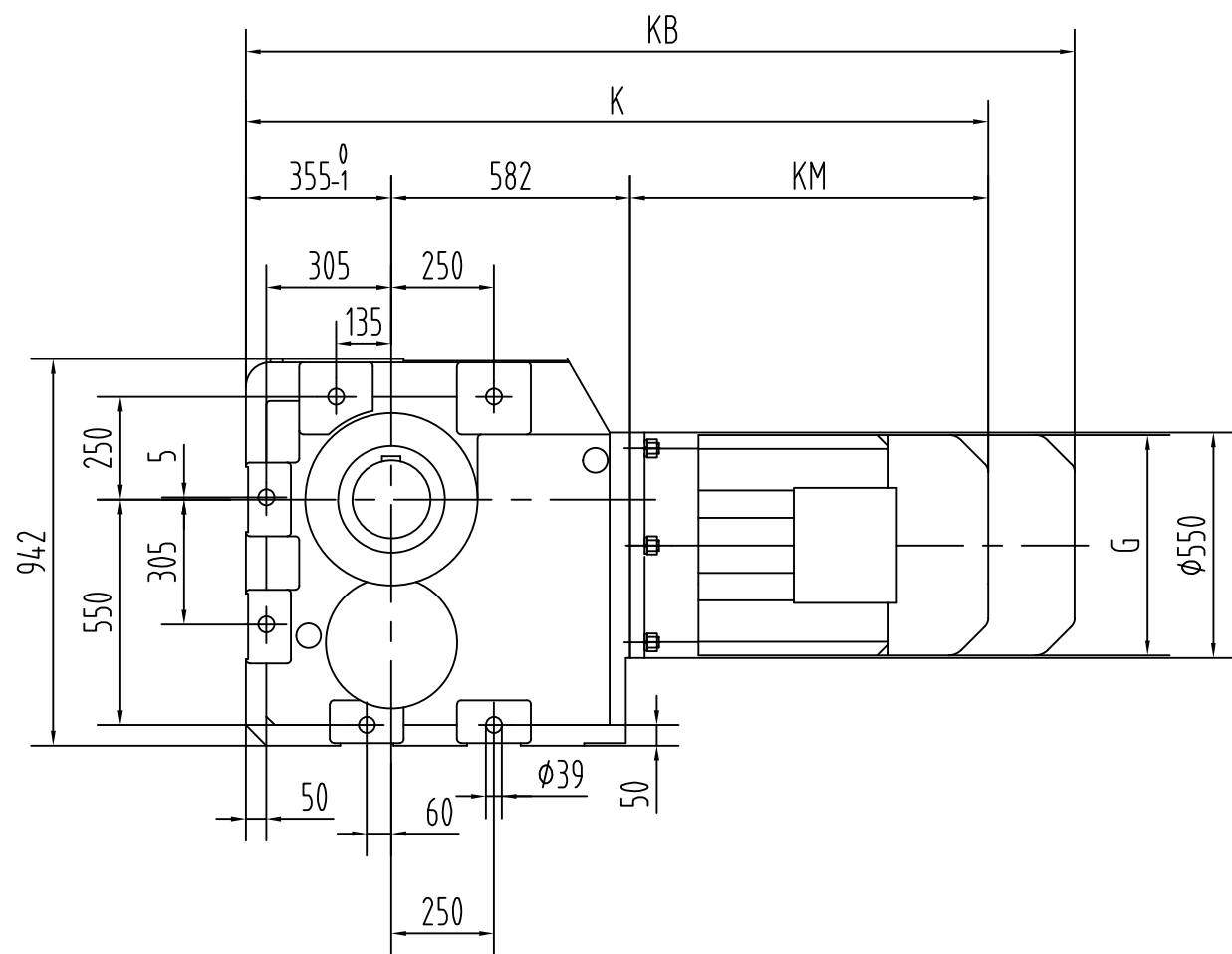
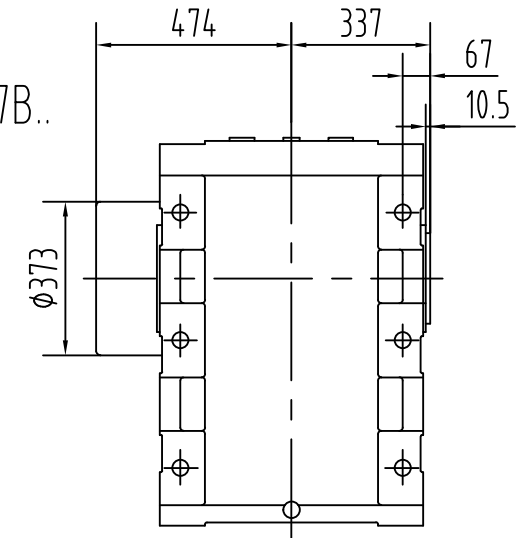

	DV160M	DV160L	DV180..	DV200..	DV225S	DV225M	D250M	D280S	D280M	D315S	D315M
G AC	330	330	380	420	470	470	510	580	580	645	645
G1 AD	255	255	280	305	335	335	370	410	410	587.5	587.5
G1B											
K	1407	1451	1478	1608	1624	1649	1714				
KB	1503	1547	1579	1758	1774	1792					
KM LB	470	514	541	671	687	712	777				

Pos.	Amount	Drawing nr.:	Material	Measurements
			Units:	Drawn by:
			Scale: 1:18	Sheet:
			Date:	Revision:
Projection:	Format:	Title: JRTK..187..		

COPYRIGHT EURONORM, THIS DOCUMENT CONTAINS CONFIDENTIAL AND PROPRIETARY INFORMATION WHICH, UNLESS OTHERWISE EXPRESSLY AGREED TO IN WRITING BY EURONORM, REMAINS THE SOLE PROPERTY OF EURONORM, AND MAY NOT BE DISCLOSED, COPIED, REDISTRIBUTED, RETRANSMITTED, PUBLISHED OR USED TO CREATE DERIVATIVE WORKS. 2013 EURONORM.